

OUR FRIEND THE

FIREFIGHTER

FIRE SAFETY TIPS • COLORING BOOK

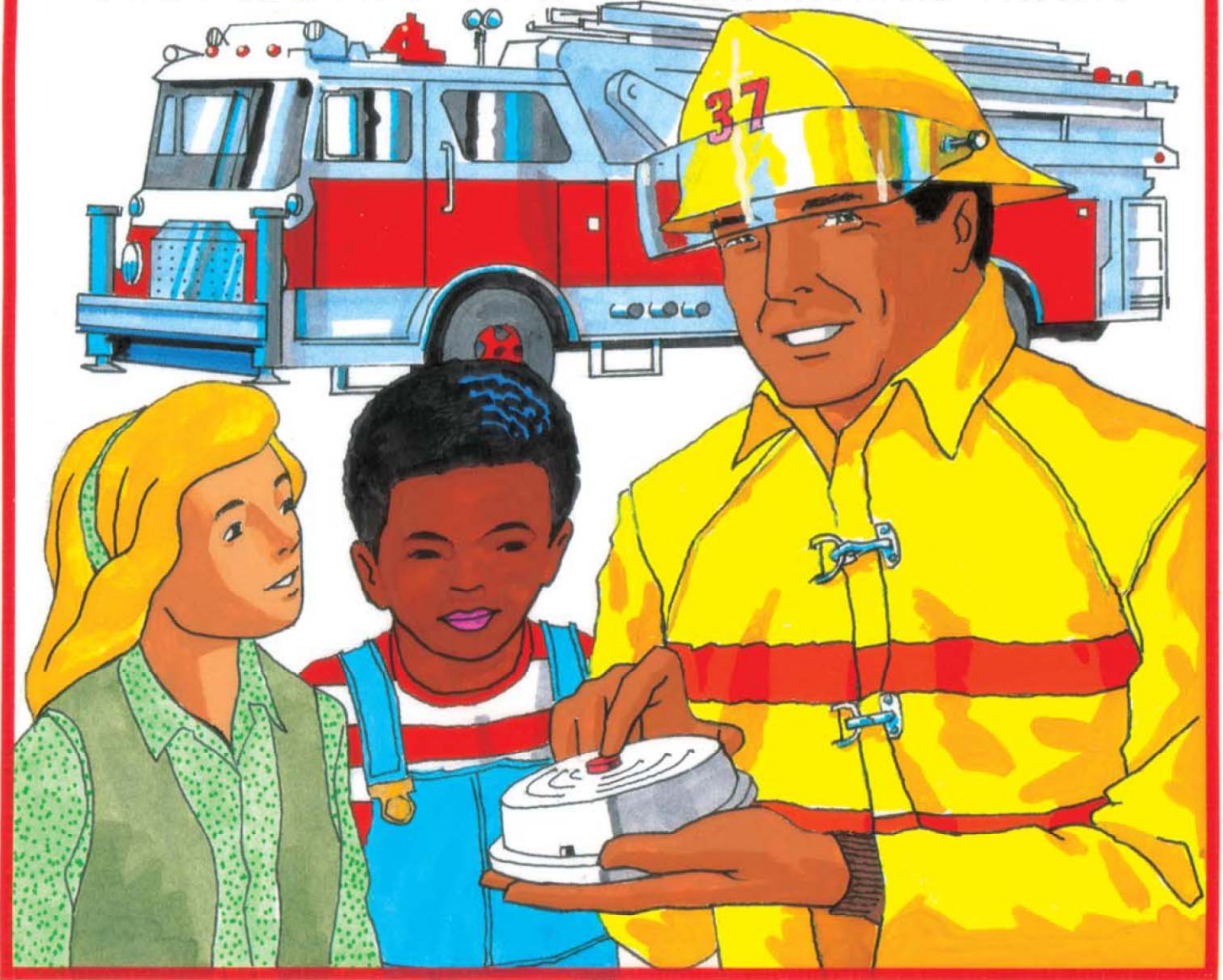

**A MESSAGE FROM
PECAN GROVE
VOLUNTEER
FIRE DEPARTMENT**



Be careful around these hot things!
They can cause a painful burn, or even
start a fire.

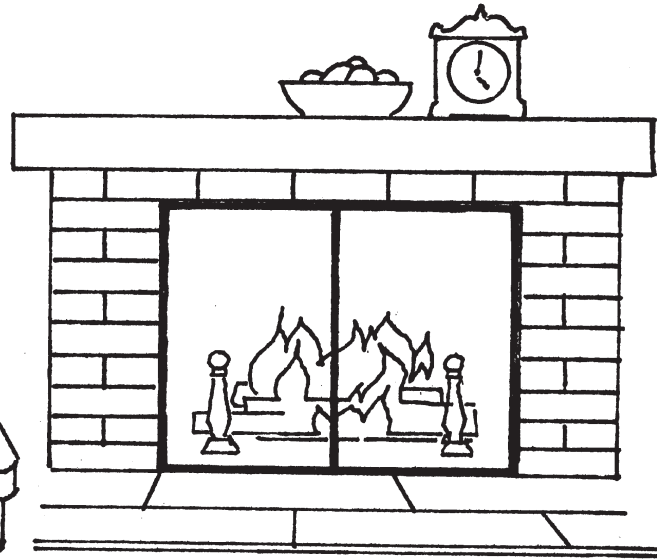
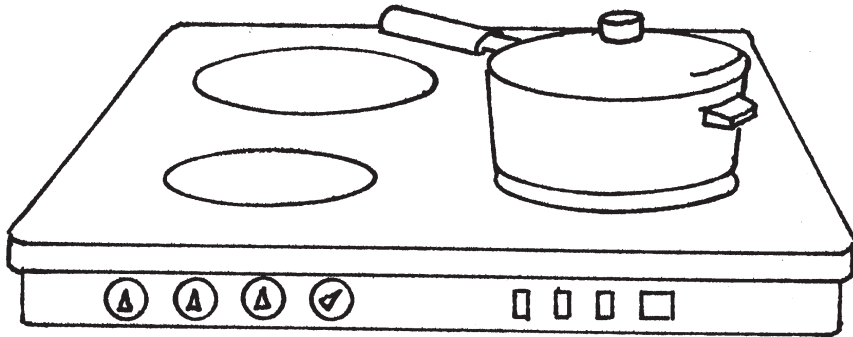

COOKING STOVES AND FIREPLACES

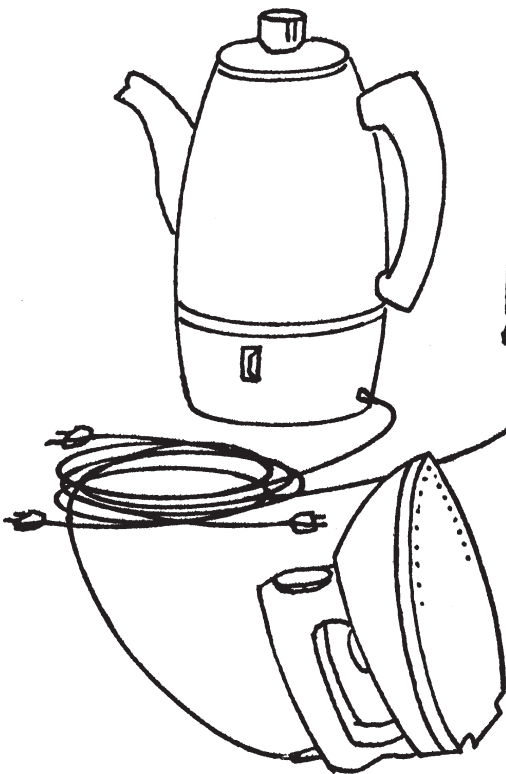

ELECTRICAL APPLIANCES
AND BARBECUES

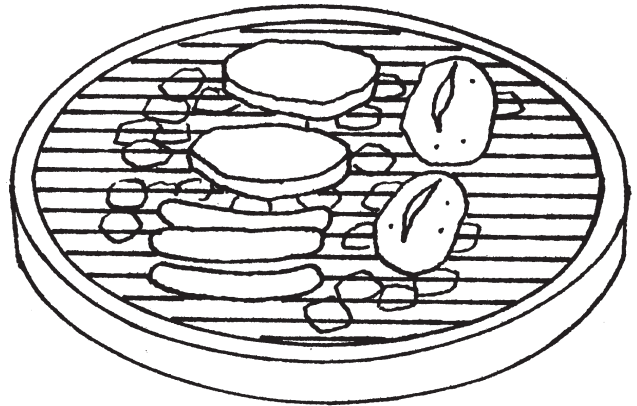

**DON'T PLAY
WITH FIRE!**

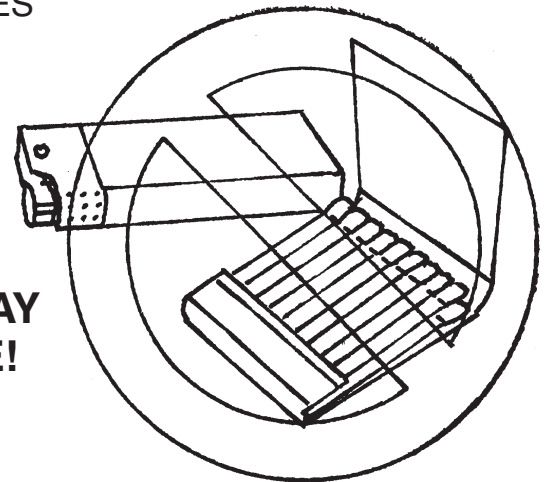

Old rags and paper can help spread a fire. Clean out your attic, cellar and garage. Recycle what you can, throw out the rest.

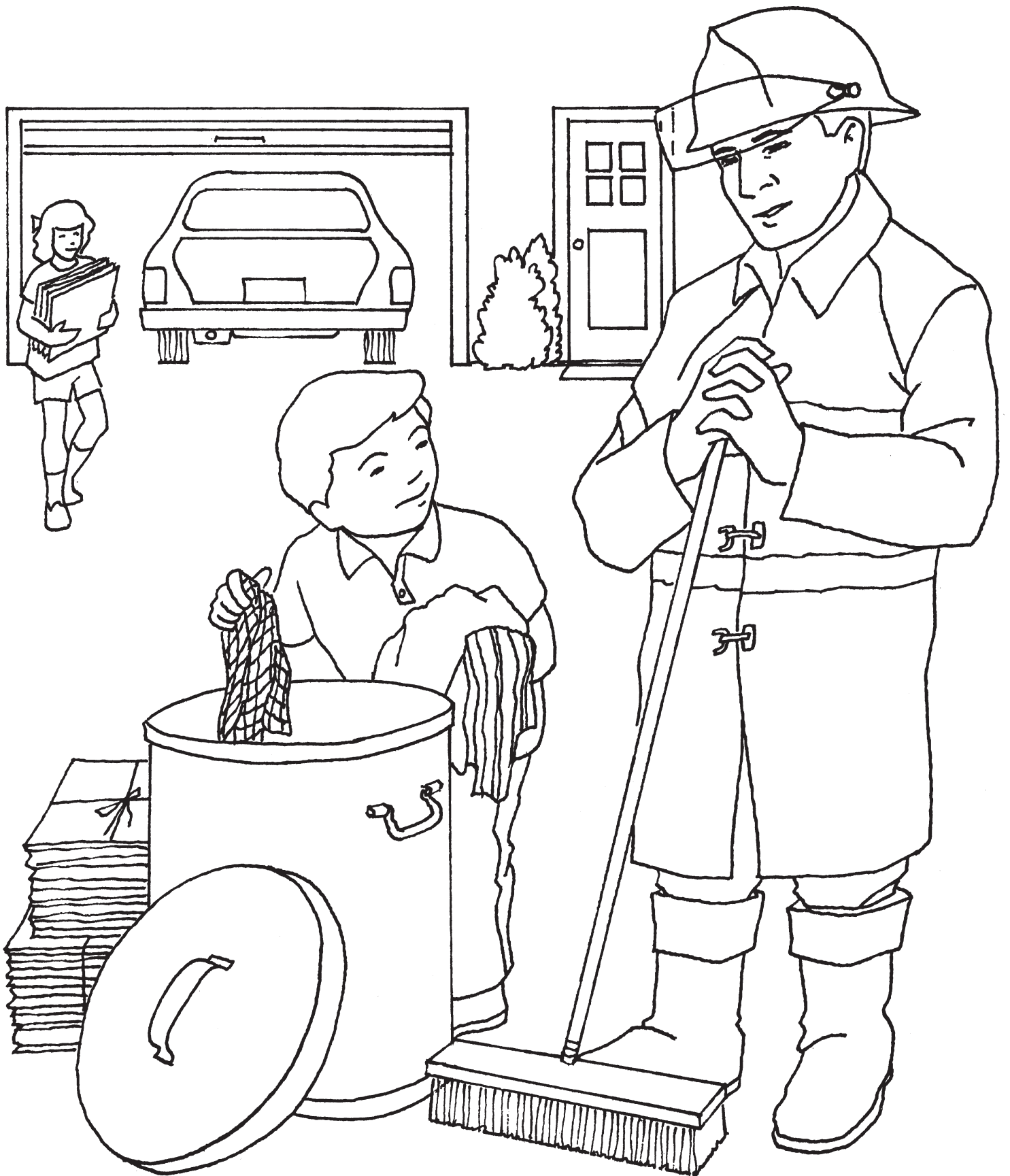

Be prepared. Be sure there are smoke detectors and fully-charged fire extinguishers throughout the house. If there is a fire, don't open a door if it is hot!



Be sure you know the fastest way out. If there is a lot of smoke, stay low. The air is clearer near the floor. Have an escape plan and “family” fire drills just like the ones at school.

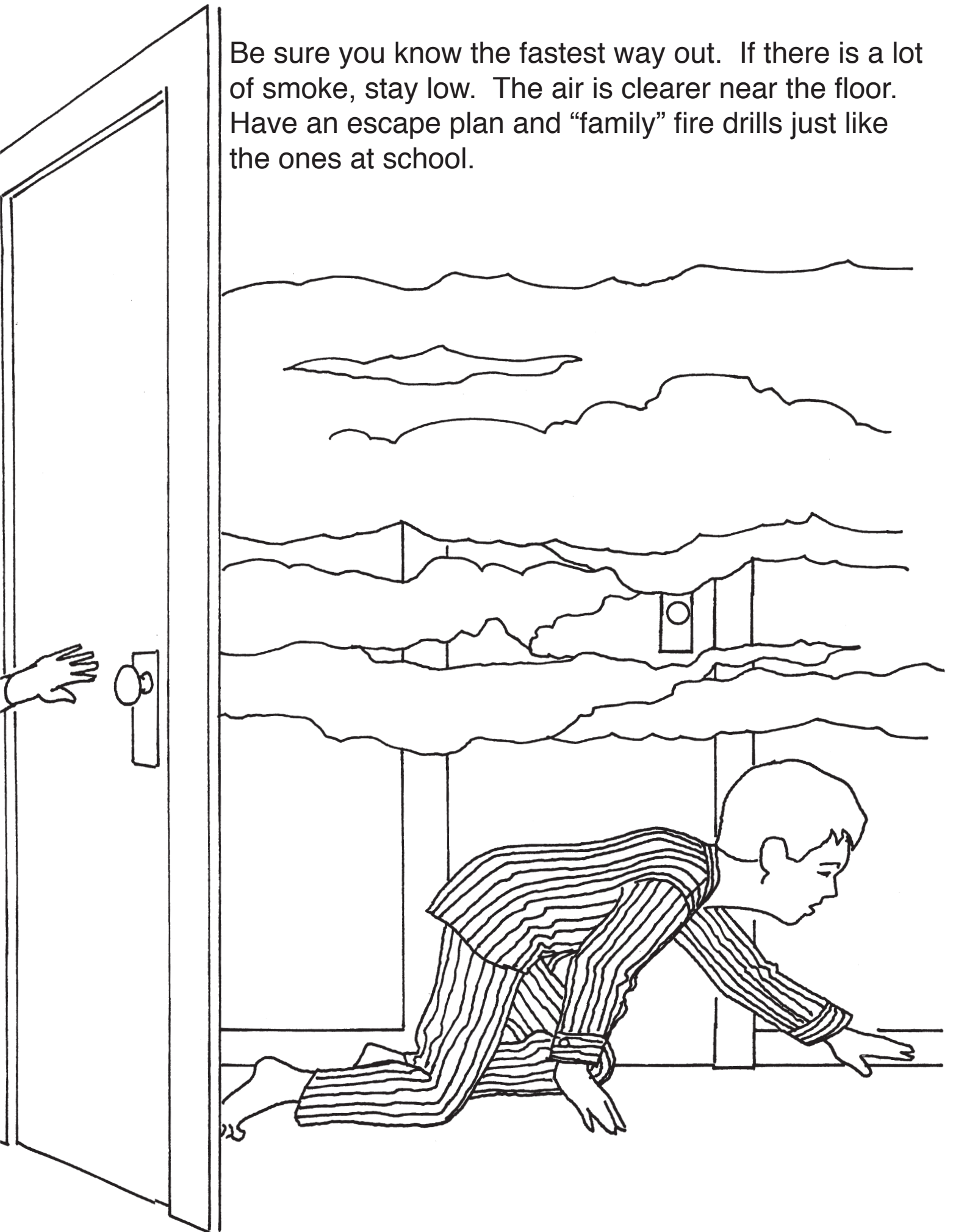

If your clothing catches fire, DON'T RUN! Roll up in a heavy rug or blanket to smother the flames. Or roll over and over on the ground. Remember: STOP. DROP. ROLL!



If you are in a burning building, a firefighter may arrive looking like this! Don't be afraid. He is there to help you. Do everything he says to do. Quickly!





Have emergency numbers printed on or near every phone in the house. Have your parents teach you how to call for help, and practice it a few times. Be sure you know your address. And remember... **DON'T PLAY WITH FIRE!**

